

Bardages écologiques – 100 % PVC Recyclé / Recyclable



L'avenir est **100 % RECYCLÉ.** 

**vinyPlus** Rond *Type Bois – filmé*

Le bardage vinyPlus est composé à 100 % de matières plastiques recyclées. vinyPlus existe en profilé Rond ou Élégie, il offre les mêmes possibilités décoratives que le bois naturel. Les profilés sont lavables et les coloris sont très stables. Il n'est plus nécessaire de repeindre ou d'ajouter des couches de lasure.



GARANTIE  
10 ANS



ECONOMIE  
D'ÉNERGIE



PVC  
RECYCLABLE



ENTRETIEN  
RÉDUIT



RÉDUCTION  
ÉMISSION



DESIGNED & MADE  
IN GERMANY



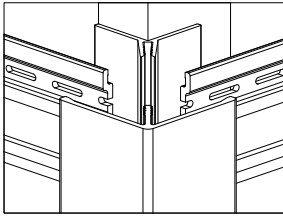

Angle sortant

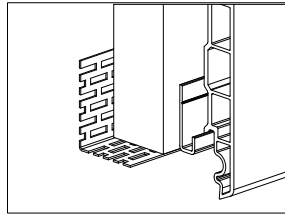

Profilé de ventilation et  
Profilé de départ

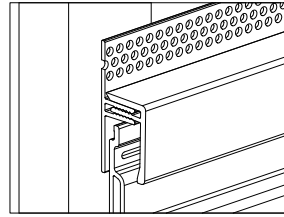

Profilé de finition

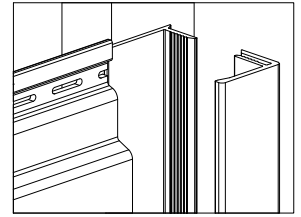

Épingle

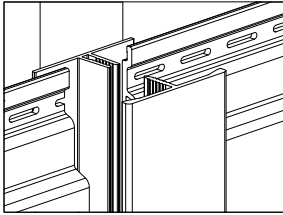

Jonction H

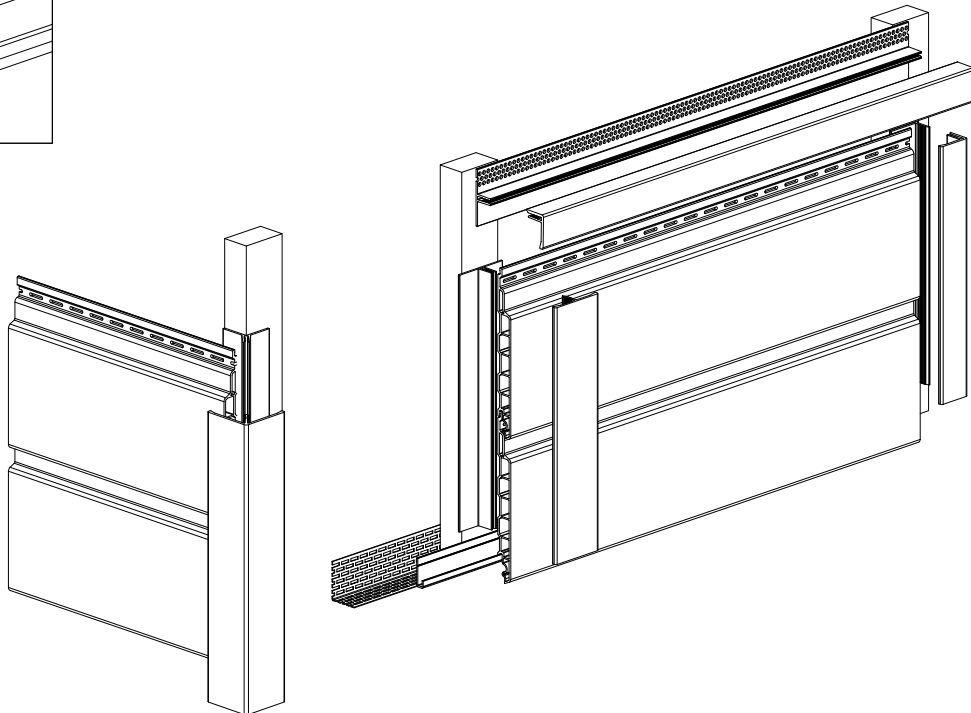

Anteak Grey



Rouge (env. RAL 3011)

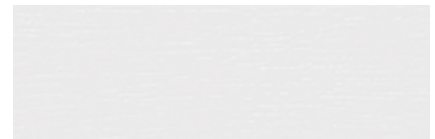

Gris clair (env. RAL 7035)



Gris (env. RAL 7001)



Gris basalt (env. RAL 7012)



Gris anthracite (env. RAL 7016)

Notice de pose



Autres décors

