



Bardages écologiques – 100 % PVC Recyclé / Recyclable



L'avenir est **100 % RECYCLÉ.** 

vinylPlus Shadow Rond *Type Bois – filmé*

Joint creux, faux claire-voie. Tout comme notre bardage vinylPlus, le bardage vinylPlus Shadow est composé à 100 % de matières plastiques recyclées et est revêtu d'un film décoratif structuré, résistant aux UV. Les films utilisés plaisent pour leur coloris et leur pluralité. Une fois posé, on obtient une façade résolument moderne et le contraste recherché d'un bardage à claire-voie.



GARANTIE
10 ANS



ECONOMIE
D'ÉNERGIE



PVC
RECYCLABLE



ENTRETIEN
RÉDUIT



RÉDUCTION
ÉMISSION



DESIGNED & MADE
IN GERMANY



vinylit.fr

vinylit
BARDAGES DURABLES



DESIGNED & MADE
IN GERMANY

vinyPlus Shadow

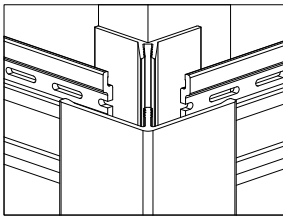

Angle sortant

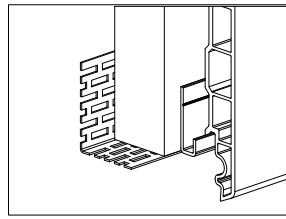

Profilé de ventilation et
Profilé de départ

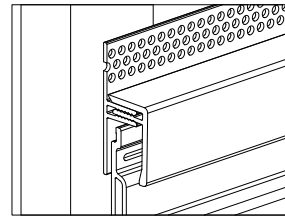

Profilé de finition

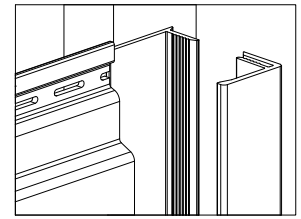

Épingle

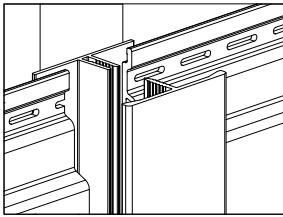

Jonction H

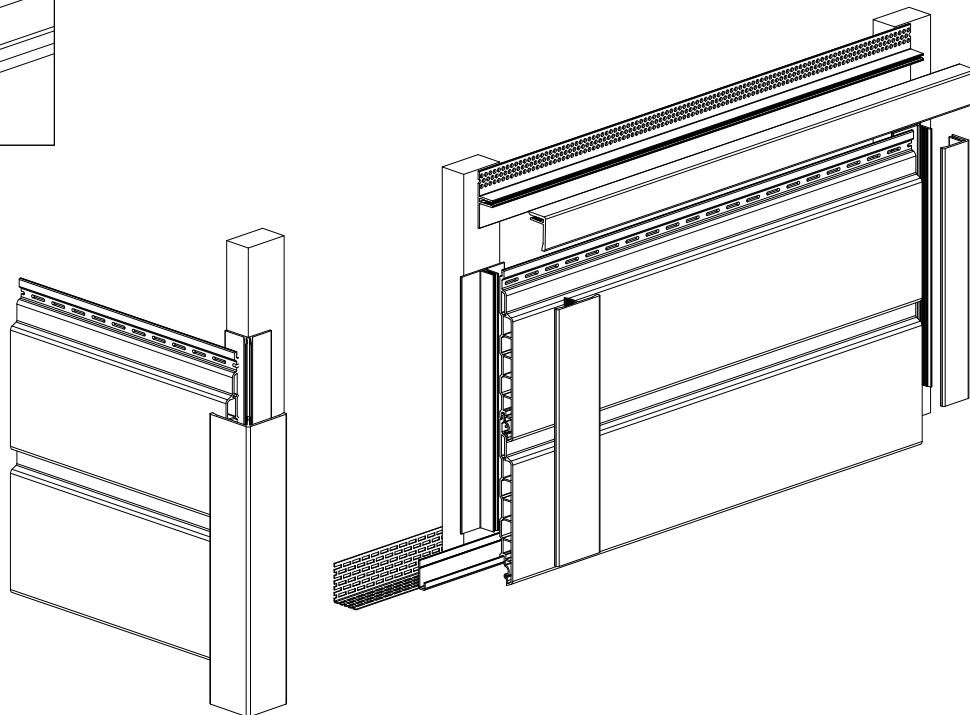

Sheffield Oak Alpin



Sheffield Oak Beton



Artisan Oak



Turner Oak Malz



Turner Oak Toffee



Kitami Oak



Notice de pose 

Autres décors 